

## SERIE ASP FX

### SCHLAUCHPUMPE

#### ANWENDUNGSBEREICH

Umwelt (Flüssigschlämme, Kalkmilch, Polymere,...), Mechanik (Öl), Chemie (Klebstoffe, Farben,...), Mineralien, Nahrungsmittel (Farbstoffe, Sirup, Rahm,...), Papier (Mineralschlämme), Öl und Gas (Bohrschlämme)

#### EIGENSCHAFTEN

- Durchsatz **min 40 L/St bis max 27'000 L/St**
- Maximaldruck : **10 bar**
- Höchsttemperatur bis **120°C**
- Selbstansaugend : **5 mCE**



#### TECHNISCHE VORTEILE

- Ein einziges Verschleissteil : der Schlauch
- Dichtungslos
- Selbstansaugend
- Reversible Förderung
- Korrosive Produkte
- Abrasive Produkte
- Empfindliche Produkte
- Hochkonzentrierte Produkte
- Partikelgrösse

#### EINBAUGRÖSSE

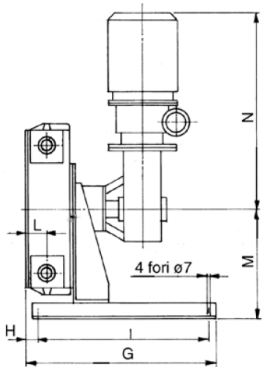

ASP 10 - 15 FX

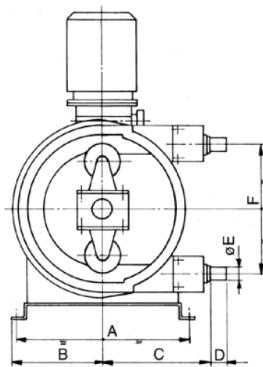

ASP 25 - 32 - 40 - 50 - 65 FX

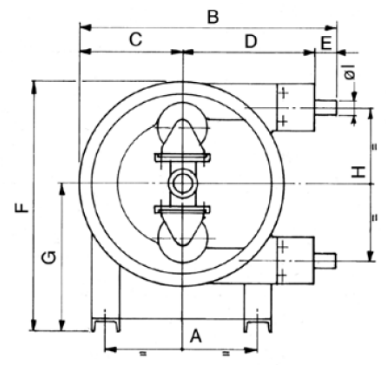
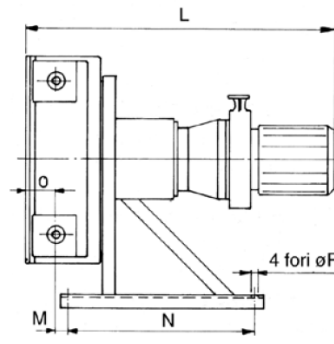

	A [mm]	B [mm]	C [mm]	D [mm]	E [mm]	F [mm]	G [mm]	H [mm]	I [mm]	L [mm]	M [mm]	N [mm]	O [mm]	P [mm]	Id* [mm]	Ge** [kg]
ASP 10 FX	210	112	169	25	15	169	251	21	220	40	184	271	-	-	10	19
ASP 15 FX	210	112	169	30	20	169	251	21	220	40	184	271	-	-	15	20
ASP 25 FX	250	415	160	210	45	380	220	254	32	491	23	400	53	11	25	48
ASP 32 FX	330	573	217	290	66	517	300	316	40	655	47	520	68	11	32	84
ASP 40 FX	420	683	270	350	75	640	370	410	50	735	56	580	74	14	40	145
ASP 50 FX	420	790	330	380	80	770	440	518	65	833	70	650	88	14	50	185
ASP 65 FX	566	1041	440	510	91	1010	570	680	80	1107	36	930	106	17	65	478

\* Di : Innendurchmesser des Rohres \*\* Gewicht

# KURVEN

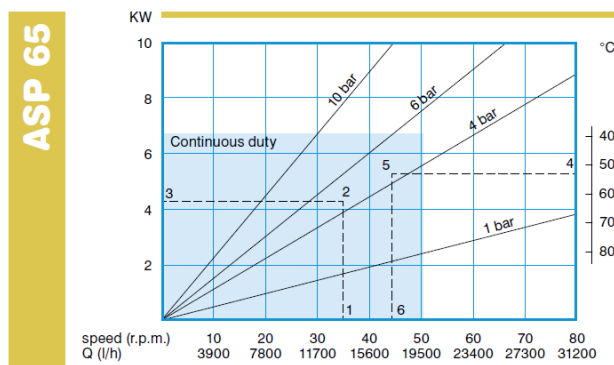
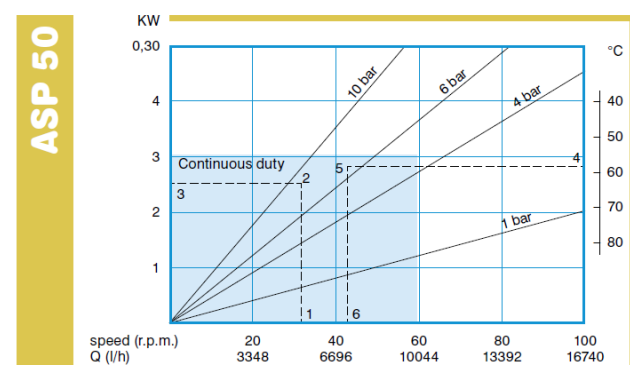
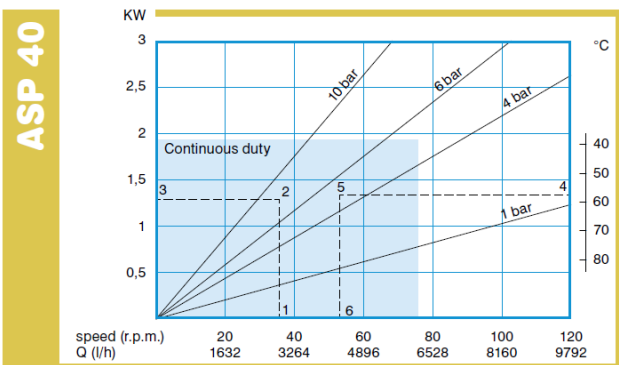
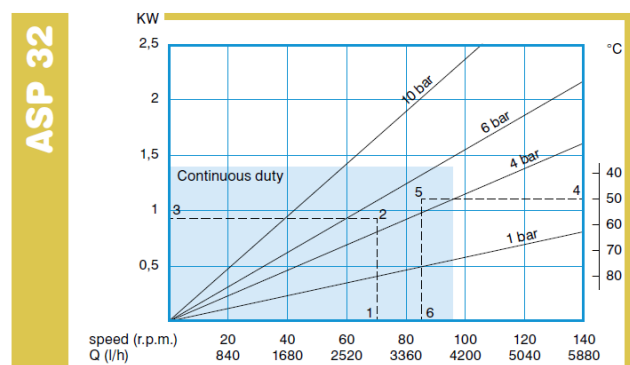
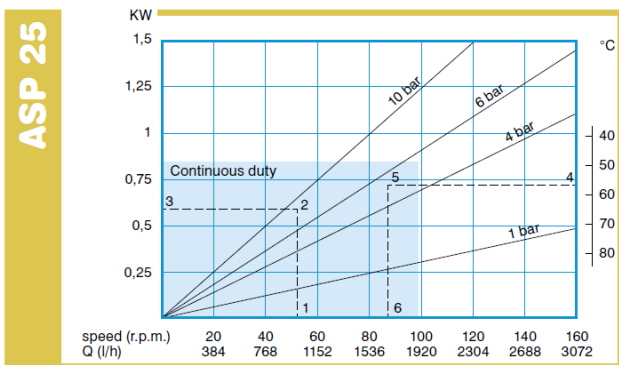
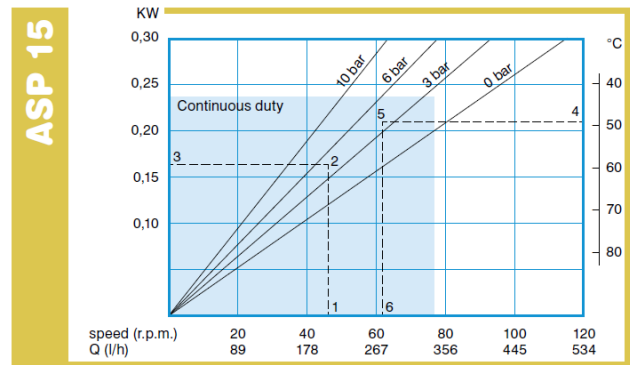
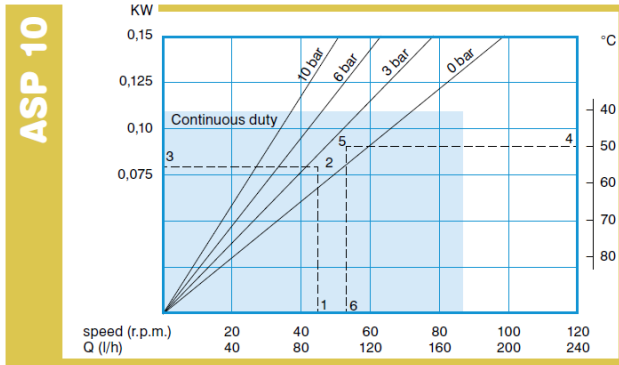

## DAS SCHLAUCHPRINZIP

Das Prinzip der Schlauchpumpe beruht auf der Fähigkeit eines Schlauchs aus flexiblem Material, sich zu verformen und anschliessend wieder seine ursprüngliche Form anzunehmen.

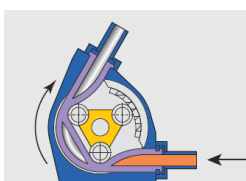

Ansaugen

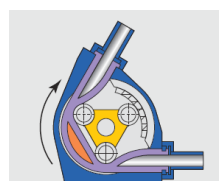

Weiterleiten

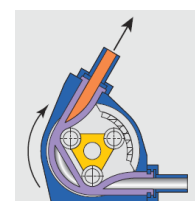

Fördern

01/2019/yp